



Product Manual

**DK-3401**  
**Alto PN 107450-3401-XXXXX**

Aircraft Cabin DECU Keypad - 4 Key Headphone with Video

Alto Aviation  
 86 Leominster Rd  
 PO Box 399  
 Sterling, MA 01564

Phone: 978.466.5992  
 800.814.0123  
 Fax: 978.466.5996  
 E-mail: tech@altoaviation.com

www.altoaviation.com

	Size	Doc Type	Drawing Number	Rev #	Date	Page
	A	PM	107450-3401-XXXXXXPM	1	06/19/15	1 of 21

### Revisions

Rev #	Date	Description
1	06/19/15	Initial Release

### Copyright/Proprietary Notice

Alto products are continually improved and all specifications are subject to change without notice. Information and data in this document is confidential and proprietary. Reproduction or disclosure of the information contained in this publication or any portion thereof, by any means, without the express written permission of Alto Technologies Corporation is prohibited.

Copyright © Alto Technologies Corporation. All rights reserved

	Size	Doc Type	Drawing Number	Rev #	Date	Page
	A	PM	107450-3401-XXXXXXPM	1	06/19/15	2 of 21



## Table of Contents

- 1.0 GENERAL INFORMATION ..... 6**
- 1.1 INTRODUCTION..... 6
- 1.2 EQUIPMENT DESCRIPTION..... 6
- 1.3 TECHNICAL SPECIFICATIONS ..... 7
- 1.4 OUTLINE DRAWING ..... 8
- 1.5 SYSTEM BLOCK DIAGRAM..... 9
- 2.0 INSTALLATION..... 10**
- 2.1 GENERAL..... 10
- 2.2 UNPACKING AND INSPECTION..... 10
- 2.3 INSTALLATION EXAMPLES..... 11
- 2.4 THE COSMETIC PLATE ..... 12
- 2.5 MOUNTING INSTRUCTIONS ..... 13
- 2.6 WIRING REQUIREMENTS ..... 16
- 2.7 CONNECTOR PINOUTS/KIT ..... 16
- 2.8 CONNECTOR TOOLS ..... 17
- 3.0 INSTRUCTIONS FOR CONTINUED AIRWORTHINESS..... 17**
- 3.1 PERIODIC MAINTENANCE ..... 17
- 4.0 KEYPAD FUNCTIONS ..... 18**
- 4.1 AUDIO CONNECTION..... 18
- 4.2 KEYPAD BUTTON FUNCTIONS ..... 18
- 4.3 CHANGING THE LED BACKLIGHT COLORS ..... 18
- 4.4 BACKLIGHT COLOR SETTINGS..... 19
- 5.0 TROUBLESHOOTING ..... 20**
- 5.1 BASIC TROUBLESHOOTING..... 20
- 6.0 ENVIRONMENTAL CATEGORIES ..... 21**

### List of Illustrations

Figure 1: DK-3401 Photo ..... 7  
 Figure 2: DK-3401 Outline Drawing ..... 8  
 Figure 3: DK-3401 Block Diagram..... 9  
 Figure 4: Installation Example Photos with Corresponding Alto Replacement Part ..... 11  
 Figure 5: Cosmetic Plate..... 12  
 Figure 6: Example Keypad Mounting Via L-Brackets ..... 13  
 Figure 7: Keypad Mounting Via Cosmetic Plate ..... 14  
 Figure 8: Keypad Thru-Panel Mounting..... 15  
 Figure 9: J2 Connector Pinouts..... 16  
 Figure 10: J3 Connector Pinouts..... 16  
 Figure 11: Mating Pin..... 17  
 Figure 12: Example LED Color Select Diagram ..... 19  
 Figure 13: Basic Troubleshooting ..... 20

**1.0 GENERAL INFORMATION**

**1.1 Introduction**

This manual contains information for the installation and operation of the DK-3401, P/N 107450-3401-XXXXX, Four Key Headphone DECU Keypad with Video.

This document includes product information such as mounting, mechanical, and electrical characteristics.

**1.2 Equipment Description**

Many customers prefer their current interior arrangement and have no intention to update it. Often, these arrangements are older and feature legacy equipment. A majority of these aircraft feature the former Baker Headphone and Speaker Digital Electronic Control Units (DECUs).

For the customer that wants the latest audio solutions without the expense of a new interior, Alto Aviation offers a retrofit DECU upgrade solution. This solution is 100% fit compatible with the existing Baker DECU panel.

The DK-3401 DECU Keypad is designed to work in concert with Alto's Digital Acapella Series Amplifiers. The headphone panel upgrade allows the passenger to experience high-fidelity sound using new Alto headphone controllers. Up to 4 sources may be supported at each location, with independent source selection and volume control.

Features:

- The Keypad features a discrete momentary ground out upon button press, which can be utilized to trigger video source selection.
- The Keypad has adjustable LED backlight colors.
- The Keypad is designed for ease of installation. It is designed to have an identical mounting footprint as legacy Baker DECU keypads. Only modifications to the existing wiring are needed to update the keypads in your aircraft.
- The audio jack is a standard 3.5mm 3-conductor type. This audio jack is used for providing headphone audio. Simply connect this jack to the headphones of your choice. This audio jack is connected to the amplifier as a headphone source output.
- The Volume Up/Down buttons produce ground logic signals that connect to Alto Acapella Series amplifiers. These ground logic signals connect to the amplifier pins by configuration per system. Please contact Alto for the correct interface documentation. As a note, the audio select function is created when both the volume up and down lines are held low. This is done internally in the panel. No external requirements are necessary to invoke the select function. The amplifier software recognizes this dual function and will sequence the audio on command.

The DK-3401 Keypad comes standard with a black anodized aluminum housing. A cosmetic plate is available in both black anodized and unplated, to allow for custom plating.

	Size A	Doc Type PM	Drawing Number 107450-3401-XXXXXPM	Rev # 1	Date 06/19/15	Page 6 of 21
--	-----------	----------------	---------------------------------------	------------	------------------	-----------------



Figure 1: DK-3401 Photo

**1.3 Technical Specifications**

DO-160G Env. Cat.

[A2X]CAB[(SC)(HR)]XWXXXXZ[X(XX)]XX[AC][XX]X[XXXXXX][XXXX]XXXX

**Connectors**

J2 Connector PN: 0436450400  
Molex Connector Plug 4 Position 3mm Single Row

J3 Connector PN: 0430250800  
Molex Connector Plug 8 Position 3mm Vertical Dual Row

**Physical Specifications**

Weight	< 4.2 oz.	(< 118 g)
Length	4.13 in	(104.8mm)
Width	1.50 in	(38.1mm)
Height	1.00 in	(25.3mm)

1.4 Outline Drawing

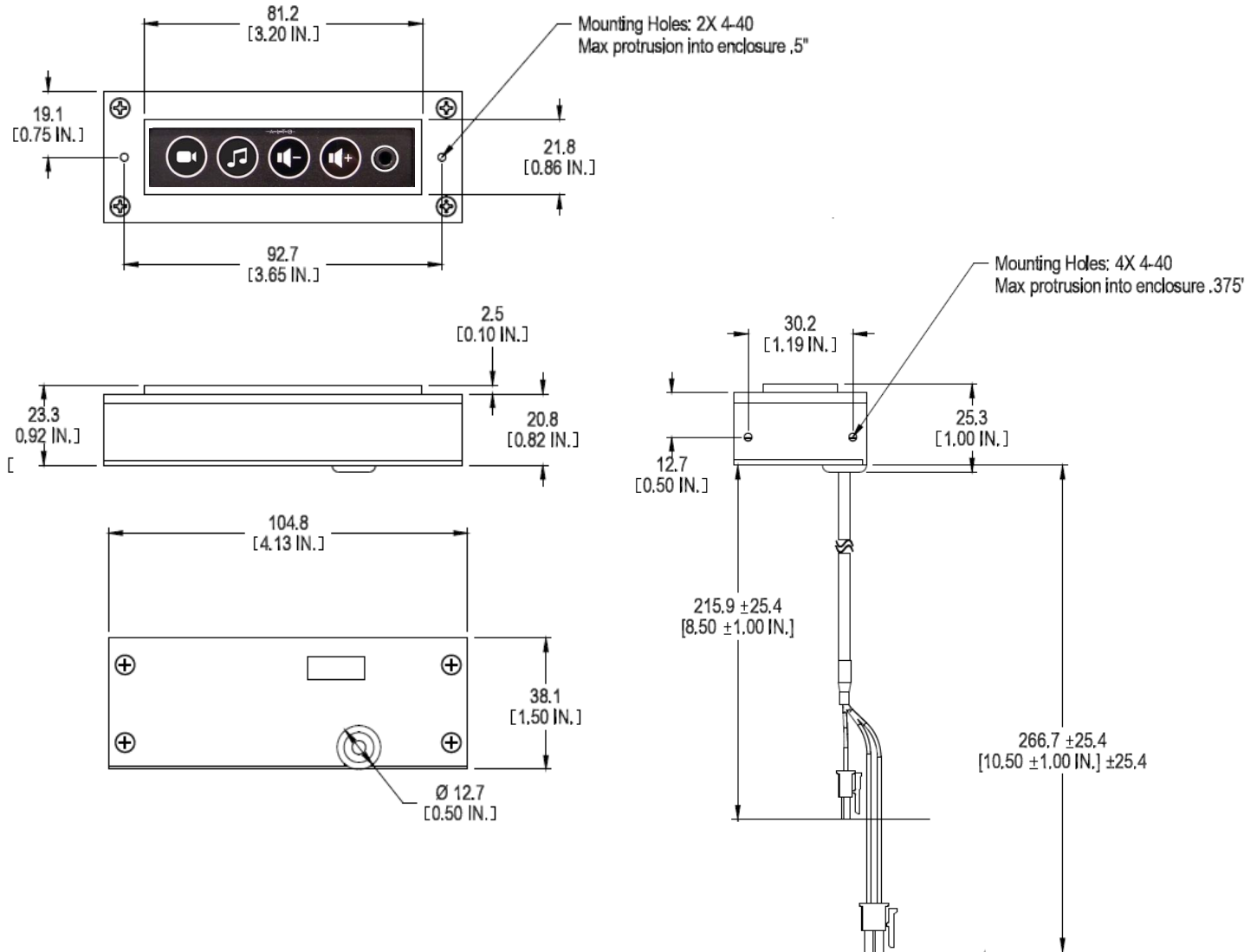

Note: Dimensions are for reference only. See DA (Delivered Assembly) drawing for exact dimensions.

Figure 2: DK-3401 Outline Drawing

	Size	Doc Type	Drawing Number	Rev #	Date	Page
	A	PM	107450-3401-XXXXXXPM	1	06/19/15	8 of 21



1.5 System Block Diagram

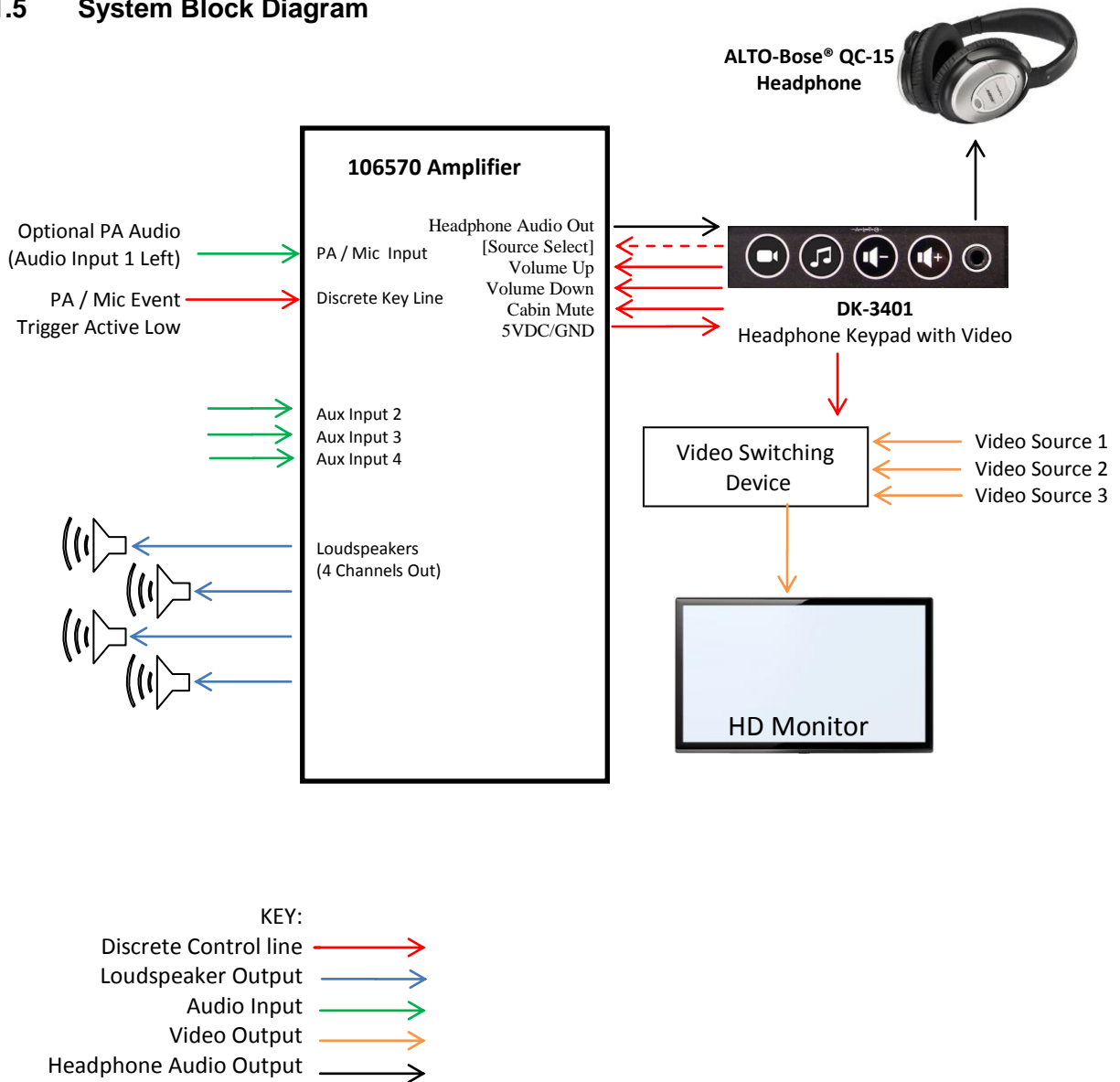

Figure 3: DK-3401 Block Diagram

**2.0 INSTALLATION**

**2.1 General**

The information in this section assists the installer of the unit. Conformity to the electrical wiring and mechanical mounting guidelines will help to ensure proper operation of the unit.

Review all information in this section before proceeding with the installation of the unit.

For assistance during installation please contact Alto using the following contact information:

**Alto Aviation**  
 86 Leominster Rd  
 PO Box 399  
 Sterling, MA 01564

Phone: 978.466.5992

800.814.0123

Fax: 978.466.5996

E-mail: tech@altoaviation.com

[www.altoaviation.com](http://www.altoaviation.com)

When connecting this unit to another manufacturer’s product, consult the manufacturer’s specifications and installation instructions pertaining to their equipment.

**2.2 Unpacking and Inspection**

Carefully open the packaging and remove the product. Visually inspect the unit for evidence of physical damage during shipment. Retain the packing materials and all documentation received with the unit. Verify that all components on the packing list have been received.

If the unit has been damaged during shipment, call Alto at 800.814.0123. A claim must be filed with Alto immediately after unpacking. Alto will assign a RMA Number (Returned Material Authorization) and give instructions for shipment. Please use the original carton and packing materials for shipping back to Alto.

	<b>Size</b> A	<b>Doc Type</b> PM	<b>Drawing Number</b> 107450-3401-XXXXXXPM	<b>Rev #</b> 1	<b>Date</b> 06/19/15	<b>Page</b> 10 of 21
--	------------------	-----------------------	---	-------------------	-------------------------	-------------------------

### 2.3 Installation Examples

Existing Baker DECU keypads and their corresponding Alto replacement model are shown.



**ALTO DK-4401**  
4 Key Cabin Entertainment Keypad



**ALTO DK-3401**  
4 Key Cabin/Headphone Keypad  
With Video

OR

**ALTO DK-3403**  
4 Key Cabin Input Keypad  
With Video



**ALTO DK-301**  
3 Key Headphone Keypad

**Figure 4: Installation Example Photos with Corresponding Alto Replacement Part**

2.4 The Cosmetic Plate



Figure 5: Cosmetic Plate

The cosmetic plate is supplied as a separate part number from the keypad assembly. This allows maximum flexibility in handling the various plating options. It is attached to the keypad assembly via 4-40 flushmount screws for easy removal and accommodating various finishes.

The standard cover is black anodized in a satin finish. If custom plating is desired, Alto has a kit with unfinished aluminum covers that are ready for plating. Shown above is an unplated cosmetic plate.

The part numbers for the two cosmetic plate kits are:

P/N	Finish	Included Hardware
201051	Unplated	Screws and Cosmetic Plate
201051-001	Black Anodized	Screws and Cosmetic Plate

2.5 Mounting Instructions

The Alto DECU keypads share the same dimensions and mounting holes as the original Baker DECU models. Keypads can be mounted with or without the customizable cosmetic plate. Keypads can be mounted horizontally or vertically, whichever orientation is most suitable for your installation. There are two 4-40 tapped holes on the keypad face by which the keypad can be mounted. There are two 4-40 tapped holes on both the left and right side of the keypad, by which the keypad can be mounted as well. Choose screw length such that the screw does not protrude too far into keypad, or else damage to the keypad will occur. Reference DA drawings for complete dimensions. See below for example mounting techniques.

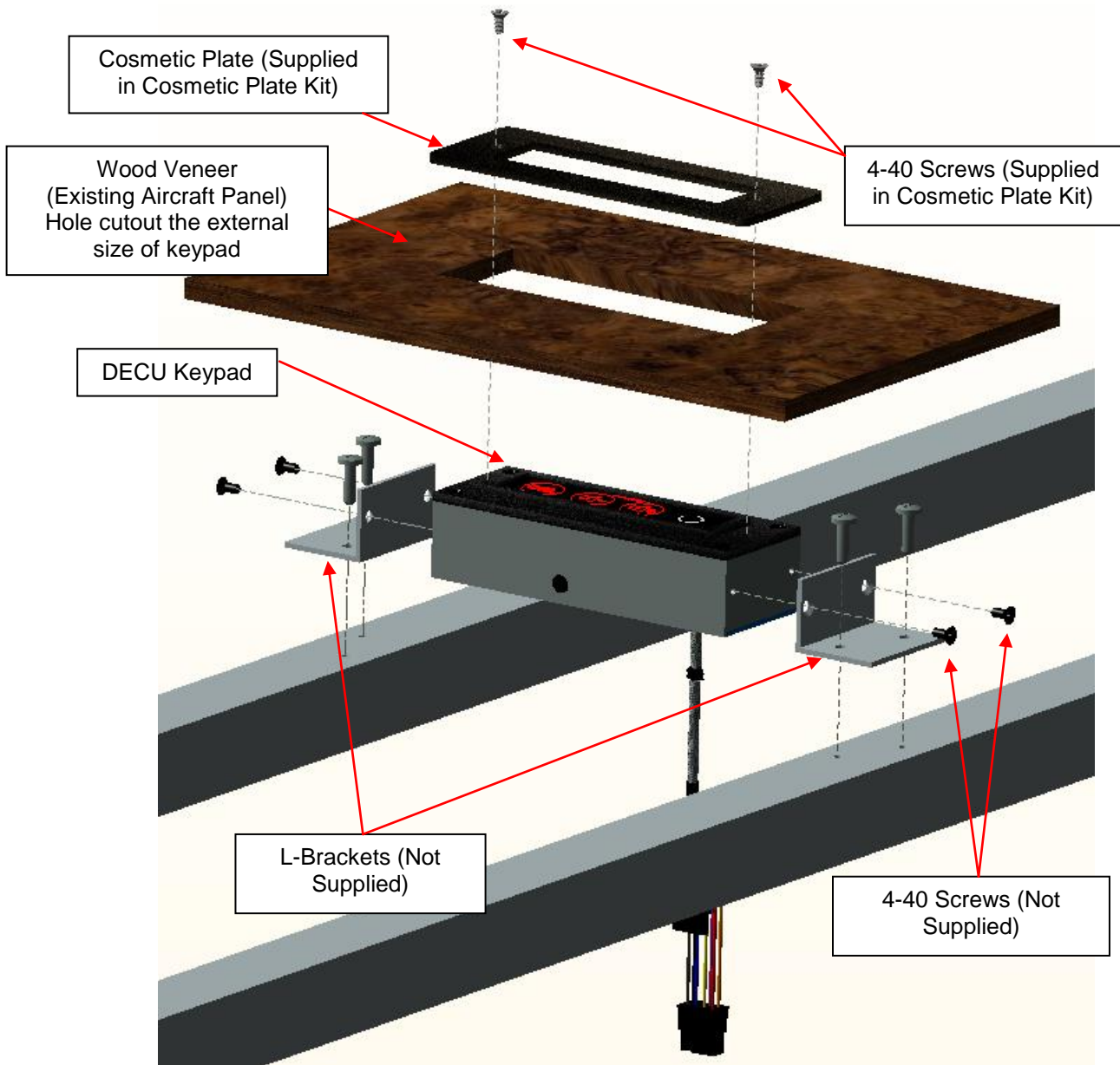

Figure 6: Example Keypad Mounting Via L-Brackets

	Size	Doc Type	Drawing Number	Rev #	Date	Page
	A	PM	107450-3401-XXXXXXPM	1	06/19/15	13 of 21

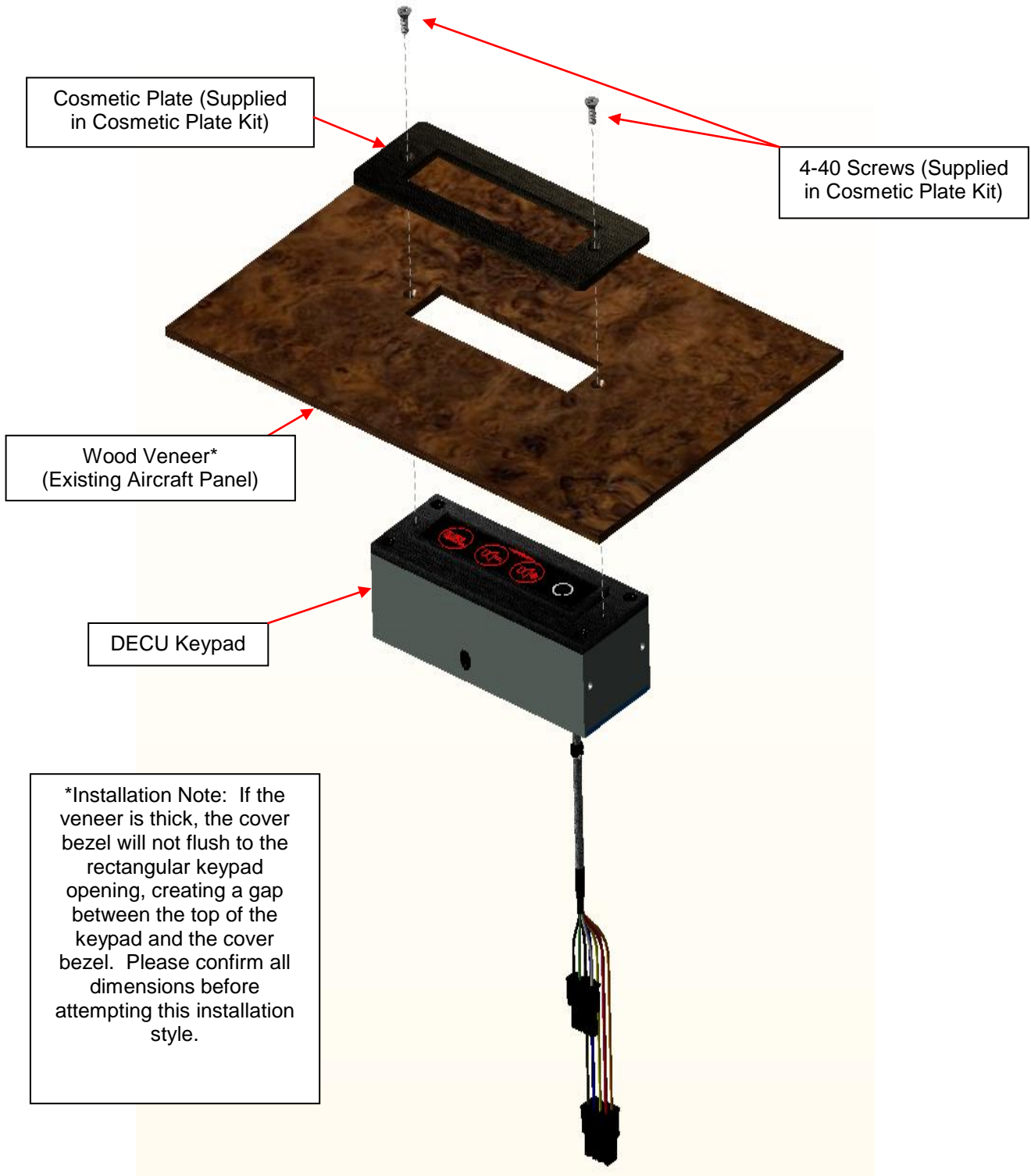

Figure 7: Keypad Mounting Via Cosmetic Plate

	Size	Doc Type	Drawing Number	Rev #	Date	Page
	A	PM	107450-3401-XXXXXXPM	1	06/19/15	14 of 21



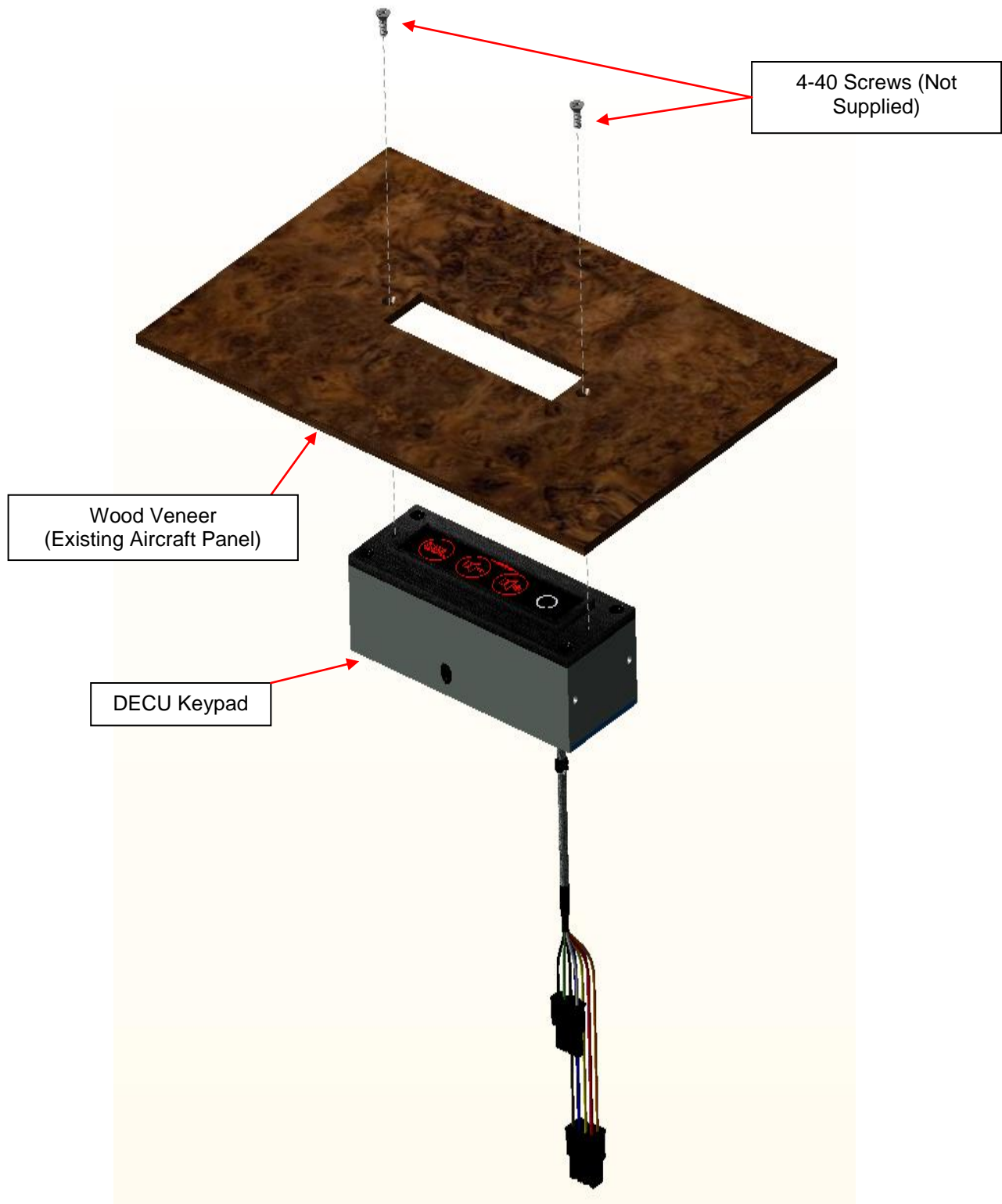



Figure 8: Keypad Thru-Panel Mounting

	Size A	Doc Type PM	Drawing Number 107450-3401-XXXXXXPM	Rev # 1	Date 06/19/15	Page 15 of 21
--	-----------	----------------	--	------------	------------------	------------------

**2.6 Wiring Requirements**

The recommended wire size is 22 AWG. The connectors can handle a range of 20-24 AWG and the final choice is up to the installing agency.

To reduce audio interference, it is important to use shielded twisted pair wire for the audio connection from the keypad to the amplifier (Connector J2)

**2.7 Connector Pinouts/Kit**

All wiring harnesses to the unit shall be supplied and fabricated by the installing agency.

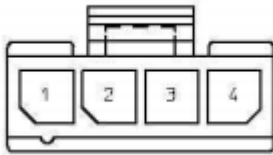

J2 Connector PN: 0436450400 (Keypad)  
 Mating Connector: 0436400401 (in Alto Kit)  
 Molex Connector Plug 4 Position 3mm Single Row

PIN	DESCRIPTION	Details
1	Headphone Left +	Twisted Pair (1&3) w/Shield(2)
2	Headphone Ground Return	Twisted Pair (1&3) w/Shield(2)
3	Headphone Right +	Twisted Pair (1&3) w/Shield(2)
4	N/C	

**Figure 9: J2 Connector Pinouts**

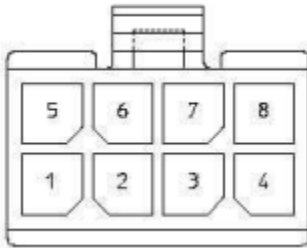

J3 Connector PN: 0430250800 (Keypad)  
 Mating Connector: 0430200801 (in Alto kit)  
 Molex Connector Plug 8 Position 3mm Vertical Dual Row

PIN	DESCRIPTION
1	+5V from Amplifier
2	HP Control 1
3	HP Control 2
4	Cabin Control 1
5	Cabin Control 2
6	Video Select- Momentary Ground Out
7	N/C
8	Ground from Amplifier

Pin Voltage vs Function		
Cabin Control 2	Cabin Control 1	Function
+3V	+3V	No function
+3V	GND	Vol. Down
GND	+3V	Vol. Up
GND	GND	Source Select

**Note:** When headphones are plugged in to 3.5mm jack, keypad controls headphone audio. When nothing is plugged in to 3.5mm jack, keypad controls cabin entertainment.

**Figure 10: J3 Connector Pinouts**



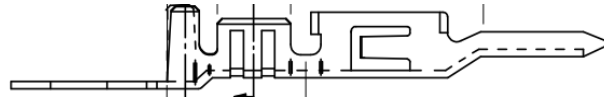

Connector Pin PN: 0510211100  
 Mating Pin: 0430310001(in Alto kit)  
 Molex Connector Terminal Male 20-24 AWG Tin

**Figure 11: Mating Pin**

Alto has a connector kit specific to these keypads. This kit contains the mating connectors and pins. One mating connector kit is required per keypad.

The part number for this kit is:

**201003 Connector Kit for Keypads**

Alto offers a D-Sub Adapter Harness Kit. The part number for this kit is:

**106361 D-Sub Adapter Harness**

Contact Alto to define the electrical interface between the keypad and the Acapella Series amplifier.

**2.8 Connector Tools**

The following tools are required for connector installation:

- Molex Crimp Tool 20-30AWG Microfit 3.0 (63819-0000)
- Molex Insertion Tool 20-30AWG Crimp (63812-0800)
- Molex Extraction Tool 20-30AWG Crimp (11-03-0043)

**3.0 INSTRUCTIONS FOR CONTINUED AIRWORTHINESS**

**3.1 Periodic Maintenance**

**No** periodic scheduled maintenance or calibration is required for continued airworthiness of this product. If the unit fails to perform to specifications, it must be removed and serviced by a qualified service facility.

	Size	Doc Type	Drawing Number	Rev #	Date	Page	
	A	PM	107450-3401-XXXXXXPM	1	06/19/15	17	of 21

**4.0 KEYPAD FUNCTIONS**

**4.1 Audio Connection**



The headphone audio out uses a standard 3.5mm stereo audio jack.

**4.2 Keypad Button Functions**

- Video Source Select- Selects Video Input, cycles through available sources.
- Audio Source Select – Selects Audio Input, cycles through available sources.
- Cabin Volume Down – Decreases cabin audio volume
- Cabin Volume Up – Increases cabin audio volume



**4.3 Changing the LED Backlight Colors**



1. Orient keypad so the wire exits towards you.
2. Peel back the decal to expose the switch
3. Adjust the colors (See Section 0)
4. Reapply the decal

### 4.4 Backlight Color Settings

The LED colors can be set by using the DIP switch on the side of the unit. There are 2 intensity settings for blue, red and green LEDs. Setting the switch upward (ON) turns the LED on. Below are some example color settings.

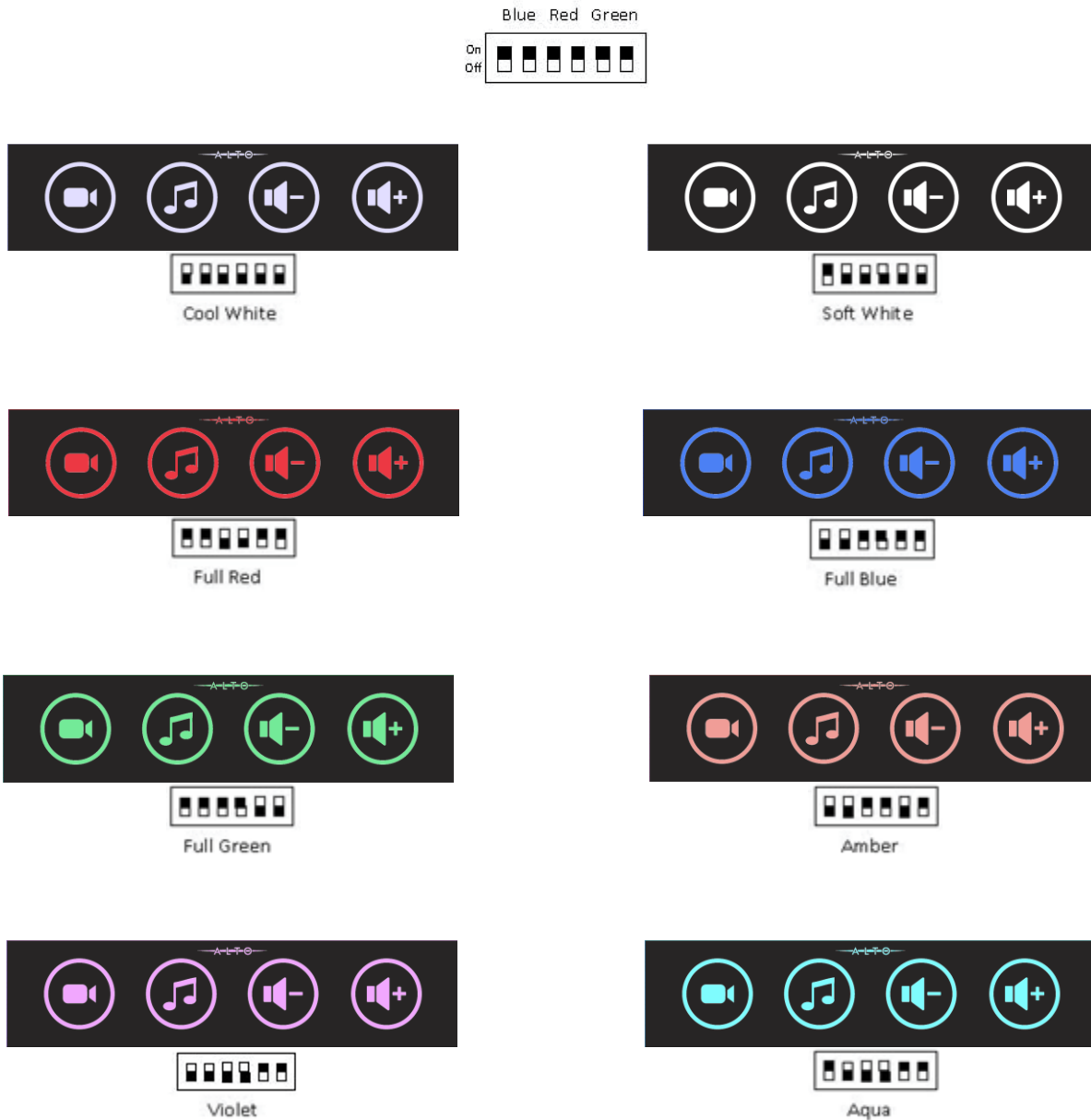

Figure 12: Example LED Color Select Diagram

5.0 TROUBLESHOOTING

5.1 Basic Troubleshooting

Problem	Possible Cause	Possible Solution
No sound	<p>Cable not fully seated</p> <p>System muted</p> <p>Amplifier is not powered ON</p> <p>Incorrect wiring</p> <p>Incorrect amplifier configuration</p>	<p>Check connection to keypad and source device.</p> <p>Press the Mute/Unmute key to toggle the mute function</p> <p>Confirm that the keypad backlight is illuminated. If not, the amplifier may be powered off.</p> <p>Confirm connection between keypad audio connector J2 and an audio input on the amplifier.</p> <p>Confirm the proper database is loaded in the amplifier. It must match the wiring scheme of the keypads. Contact Alto for help.</p>
Poor audio quality	<p>Bad input cable</p> <p>Audio device volume set too low or too high</p>	<p>Wiggle the cable near the plugs. If noisy or audio cuts in and out, replace the cable.</p> <p>Set the input device volume to a moderate level and adjust the keypad volume for desired cabin sound. Too high of an input signal could become distorted. Too low of an input level could be introduce noise.</p>
No LED backlight	<p>No power from the amplifier</p> <p>LED dip switches are all set to OFF</p>	<p>Confirm the amplifier is ON</p> <p>See section 4.3 to set the color of the backlight</p>

Figure 13: Basic Troubleshooting

6.0 ENVIRONMENTAL CATEGORIES

<i>Environmental Tests</i>	<i>RTCA/DO-160G Section</i>	<i>Conducted Test Category</i>
Temperature and Altitude		
Low Temp	4.5.1 & 4.5.2	Qualified by Similarity to Category <b>A2</b> , -55C, -40C, -15C
High Temp	4.5.3 & 4.5.4	Qualified by Similarity to Category <b>A2</b> , +85C, +70C
In-Flight Loss of Cooling	4.5.5	Identified as Category <b>X</b> Not applicable, cooling not required
Altitude	4.6.1	Identified as Category <b>X</b>
Decompression	4.6.2	Identified as Category <b>X</b> , no test performed
Overpressure	4.6.3	Identified as Category <b>X</b> , no test performed
Temperature Variation	5	Qualified by Similarity to Category <b>C</b>
Humidity	6	Qualified by Similarity to Category <b>A</b>
Operational Shocks & Crash Safety	7	Qualified by Similarity to Category <b>B</b>
Vibration	8	Qualified by Similarity to Category <b>S(C), H(R)</b>
Explosion Proofness	9	Identified as Category <b>X</b> , no test performed
Waterproofness	10	Qualified by Similarity to Category <b>W</b>
Fluids Susceptibility	11	Identified as Category <b>X</b> , no test performed
Sand and Dust	12	Identified as Category <b>X</b> , no test performed
Fungus Resistance	13	Identified as Category <b>X</b> , no test performed
Salt Spray	14	Identified as Category <b>X</b> , no test performed
Magnetic Effects	15	Qualified by Similarity to Category <b>Z 0&lt;D&lt;0.3M</b>
Power Input	16	Identified as Category <b>X</b> , Not applicable, Unit is powered by +5VDC feed from equipment qualified to <b>ZXX</b>
Voltage Spike	17	Identified as Category <b>X</b> , Not applicable, Unit is powered by +5VDC feed from equipment qualified to <b>ZXX</b>
Audio Frequency Conducted Susceptibility	18	Identified as Category <b>X</b> , Not applicable, Unit is powered by +5VDC feed from equipment qualified to <b>ZXX</b>
Induced Signal Susceptibility	19	Qualified by Similarity to Category <b>AC</b>
Radio Frequency Susceptibility	20	Identified as Category <b>XX</b> , no test performed
Emission of Radio Frequency Energy	21	Identified as Category <b>X</b> , EUT is composed of passive and 5VDC components. No high frequency signals present
Lightning Induced Transient Susceptibility	22	Identified as Category <b>XXXXXX</b> Pin Injection <b>XX</b> , no test performed Cable Bundle <b>XX</b> , no test performed Burst <b>XX</b> , no test performed
Lightning Direct Effects	23	Identified as Category <b>X</b> , no test performed
Icing	24	Identified as Category <b>X</b> , no test performed
Electrostatic Discharge	25	Identified as Category <b>X</b> , no test performed
Fire, Flammability	26	Identified as Category <b>X</b> , no test performed